



Planning and Development Department
Land Use Planning Division

A D M I N I S T R A T I V E U S E P E R M I T

CITY OF BERKELEY ZONING ORDINANCE
Berkeley Municipal Code, Title 23

AUP #2013-0161

Property Address: **1125 CHANNING WAY**

Permittee Name: **CHRIS SULLIVAN**

Use and/or Construction Permitted: to demolish a 438 sq. ft. garage, 12'10" in height and replace it with a 438 sq. ft. accessory building containing an office space with a sink and water closet, with an average height of 12' and establish one uncovered off-street parking space pursuant to:

- Section 23D.08.A to allow an accessory building containing habitable space;
- Section 23D.08.010.B to allow an accessory building to exceed 10' in average height when within 4' of a property line; and
- Section 23D.28.050 to allow a fifth bedroom to a parcel.

FINDINGS, CONDITIONS AND APPROVED PLANS ATTACHED

Following the expiration of the mandatory appeal period set forth in Section 23B.28.040 of the Berkeley Municipal Code, with no timely appeal being filed, the Administrative Use Permit described herein has been duly granted by the Zoning Officer on February 20, 2014.

Attest: Greg Powell
Greg Powell, Senior Planner
For Eric Angstadt, Zoning Officer

February 20, 2014
Effective Date

ATTACHMENT 1

FINDINGS AND CONDITIONS

JANUARY 30, 2014

1125 Channing Way

Administrative Use Permit #AUP13-0161

To demolish an existing 438 sq. ft. garage, 12'10" in height, and replace it with a 438 sq. ft. accessory building containing an office space with a sink and water closet, with an average height of 12' and establish one uncovered off-street parking space.

CEQA FINDINGS

1. The project is categorically exempt from the provisions of the California Environmental Quality Act (CEQA, Public Resources Code §21000, et seq. and California Code of Regulations, §15000, et seq.) pursuant to Section 15303 of the CEQA Guidelines ("New Construction or Conversion of Small Structures"). Furthermore, none of the exceptions in CEQA Guidelines Section 15300.2 apply, as follows: (a) the site is not located in an environmentally sensitive area, (b) there are no cumulative impacts, (c) there are no significant effects, (d) the project is not located near a scenic highway, (e) the project site is not located on a hazardous waste site pursuant to Government Code Section 65962.5, and (f) the project will not affect any historical resource.

FINDINGS FOR APPROVAL

2. As required by Section 23B.28.050.A of the Zoning Ordinance, the project, under the circumstances of this particular case existing at the time at which the application is granted, will not be detrimental to the health, safety, peace, morals, comfort, and general welfare of the persons residing or working in the neighborhood of such proposed use or be detrimental or injurious to property and improvements of the adjacent properties, the surrounding area or neighborhood, or to the general welfare of the City because:
 - As required under Section 23D.08.A and 23D.08.010.B, the proposed 438 sq. ft., 12' tall accessory building, setback 2'6" from the side property line and 3' from the rear property line, where 10' in height is required, which contains an office, including a sink and water closet, does not create significant impacts to privacy, sunlight, air, or views and is found to be non-detrimental and permissible for the following reasons:
 - 1) Privacy – a) Building separations and proximities to adjacent residential structures are greater than the district standards for main buildings and are therefore found to be adequate; b) the nearest adjacent residential structure to the east at 1129 Channing is approximately 28' and to the north at 1126

- Chaucer the nearest residential structure is approximately 48'; c) The building will be used as an office; d) The construction of the accessory building will include soundproofing materials; and e) The project is subject to condition of approval #12 that requires that a "Notice of Limitation of Use" be placed on the deed to the property. Such deed restriction will prohibit the accessory building from being used as a dwelling and restrict the extent of interior renovations (see conditions of approval below);
- 2) Sunlight – Due to the more than adequate separation from neighboring residential structures, the proposed accessory building, 12' in average height, is not expected to create significant new shadows to any adjacent residential structures;
 - 3) Air – The proposed accessory building has adequate building separations between the neighboring developments on abutting properties, thereby allowing for adequate air circulation; and
 - 4) Views – The proposed accessory building is not expected to significantly block the adjacent neighbors' views of any significant features.
- The establishment of the required off-street parking, located in the rear yard, outside of required setbacks is allowed under Section 23D.12.080 (Site Location and Screening of Uncovered Parking Spaces and Driveways).
 - Although the habitable space is not intended as a bedroom as defined and required under Section 23D.28.050, the habitable space is not expected to be detrimental to the health, safety, peace, morals, comfort or general welfare of persons residing or working in the area or neighborhood of the proposal or be detrimental or injurious to property and improvements of the adjacent properties, the surrounding area or neighborhood or to the general welfare of the City.

STANDARD CONDITIONS

The following conditions, as well as all other applicable provisions of the Zoning Ordinance, apply to this Permit:

1. Conditions Shall be Printed on Plans

The conditions of this Permit shall be printed on the *second* sheet of each plan set submitted for a building permit pursuant to this Use Permit, under the title 'Use Permit Conditions'. *Additional sheets* may also be used if the *second* sheet is not of sufficient size to list all of the conditions. The sheet(s) containing the conditions shall be of the same size as those sheets containing the construction drawings; 8-1/2" by 11" sheets are not acceptable.

2. Applicant Responsible for Compliance with Conditions

The applicant shall ensure compliance with all of the following conditions, including submittal to the project planner of required approval signatures at the times specified. Failure to comply with any condition may result in construction being stopped, issuance of a citation, and/or modification or revocation of the Use Permit.

3. Uses Approved Deemed to Exclude Other Uses (Section 23B.56.010)

- A. This Permit authorizes only those uses and activities actually proposed in the application, and excludes other uses and activities.
- B. Except as expressly specified herein, this Permit terminates all other uses at the location subject to it.

4. Modification of Permits (Section 23B.56.020)

No change in the use or structure for which this Permit is issued is permitted unless the Permit is modified by the Zoning Officer, except that the Zoning Officer may approve changes that do not expand, intensify, or substantially change the use or building.

5. Plans and Representations Become Conditions (Section 23B.56.030)

Except as specified herein, the site plan, floor plans, building elevations and/or any additional information or representations, whether oral or written, indicating the proposed structure or manner of operation submitted with an application or during the approval process are deemed conditions of approval.

6. Subject to All Applicable Laws and Regulations (Section 23B.56.040)

The approved use and/or construction is subject to, and shall comply with, all applicable City Ordinances and laws and regulations of other governmental agencies. Prior to construction, the applicant shall identify and secure all applicable permits from the Building and Safety Division, Public Works Department and other affected City divisions and departments.

7. Exercised Permit for Use Survives Vacancy of Property (Section 23B.56.080)

Once a Permit for a use is exercised and the use is established, that use is legally recognized, even if the property becomes vacant, except as set forth in Standard Condition #8, below.

8. Exercise and Lapse of Permits (Section 23B.56.100)

- A. A permit for the use of a building or a property is exercised when, if required, a valid City business license has been issued, and the permitted use has commenced on the property.
- B. A permit for the construction of a building or structure is deemed exercised when a valid City building permit, if required, is issued, and construction has lawfully commenced.
- C. A permit may be declared lapsed and of no further force and effect if it is not exercised within one year of its issuance, except that permits for construction or alteration of structures or buildings may not be declared lapsed if the permittee has: (1) applied for a building permit; or, (2) made substantial good faith efforts to obtain a building permit and begin construction, even if a building permit has not been issued and/or construction has not begun.

9. Indemnification Agreement

The applicant shall hold the City of Berkeley and its officers harmless in the event of any legal action related to the granting of this Permit, shall cooperate with the City in defense of such action, and shall indemnify the City for any award of damages or attorneys fees that may result.

ADDITIONAL CONDITIONS IMPOSED BY THE ZONING OFFICER

Pursuant to BMC 23B.28.050.D, the Zoning Officer attaches the following additional conditions to this Permit:

Prior to Submittal of Any Building Permit:

- 10.** The applicant shall provide the project planner with the name and telephone number of the individual empowered to manage construction noise from the project. The individual's name, telephone number, and responsibility for noise management shall be posted at the project site for the duration of construction in a location easily visible to the public. The individual shall record all noise complaints received and actions taken in response, and submit written reports of such complaints and actions to the project planner on a weekly basis. **Individual Responsible for Noise Management:**

Name: _____ Phone: _____

- 11.** The applicant and all persons associated with the project are hereby notified that a Transportation Management Permit (TMP) would be required under any of the following circumstances:

- Alterations, closures, or blockages to sidewalks or pedestrian paths

- Alterations, closures, or blockages to vehicle travel lanes (including bicycle lanes)
- Storage of building materials, dumpsters, debris anywhere in the public ROW
- Provision of exclusive contractor parking on-street
- Significant truck activity.

Contact the Permit Service Center (PSC) at 2120 Milvia Street or 981-7500 for details on obtaining Construction/No Parking Permits (and associated signs and accompanying dashboard permits). Public Works Traffic Engineering (981-6400) reviews all submitted TMP requests.

The TMP may include designation of a specific truck haul route. Meter heads (if in the construction area) shall be removed only by City staff. Contact the site inspector 72 hours in advance of required removal so arrangements can be made.

Prior to Issuance of Any Building Permit:

12. All owners of record of the subject property shall sign and record with the Alameda County Clerk-Recorder a "Notice of Limitation on Use of Property" (available from Land Use Planning Division) and provide a recorded copy thereof to the project planner. This Notice of Limitation shall stipulate that no part of this accessory building shall be used or converted to use a dwelling unit unless and until permission is requested of the City of Berkeley and authorized a Use Permit, Administrative Use Permit, or Zoning Certificate, whichever is applicable. This limitation shall include the explicit acknowledgment that no shower, tub, or kitchen facilities may be installed in this habitable accessory building. This limitation may not be revised or removed from this property without the prior written permission of the Zoning Officer of the City of Berkeley.
13. Drainage plans shall be submitted for approval of the Building & Safety Division and Public Works Department, if required.

During Construction:

14. Construction activity shall be limited to between the hours of 8:00 a.m. and 6:00 p.m. on Monday through Friday, and between 9:00 a.m. and noon on Saturday. No construction-related activity shall occur on Sunday or on any Federal Holiday.
15. If underground utilities leading to adjacent properties are uncovered and/or broken, the contractor involved shall immediately notify the Public Works Department and the Building & Safety Division, and carry out any necessary corrective action to their satisfaction.
16. Subject to approval of the Public Works Department, the applicant shall repair any damage to public streets and/or sidewalks by construction vehicles traveling to or from the project site.

17. All piles of debris, soil, sand, or other loose materials shall be covered at night and during rainy weather with plastic at least one-eighth millimeter in thickness and secured to the ground.
18. All active construction areas shall be watered at least twice daily, and all piles of debris, soil, sand or other loose materials shall be watered or covered.
19. Trucks hauling debris, soil, sand, or other loose materials shall be covered or required to maintain at least two feet of board.
20. Public streets shall be swept (preferably with water sweepers) of all visible soil material carried from the site.
21. The applicant shall establish and maintain drainage patterns that do not adversely affect adjacent properties and rights-of-way.
22. The applicant shall ensure that all excavation takes into account surface and subsurface waters and underground streams so as not to adversely affect adjacent properties and rights-of-way.
23. Any construction during the wet season shall require submittal of a soils report with appropriate measures to minimize erosion and landslides, and the developer shall be responsible for following these and any other measures required by the Building and Safety Division and the Public Works Department.

Prior to Issuance of Occupancy Permit or Final Inspection:

24. All construction at the subject property shall substantially conform to the approved Use Permit drawings or to modifications approved by the Zoning Officer.
25. All landscape, site and architectural improvements shall be completed per the attached approved drawings dated **DECEMBER 17, 2013**.

At All Times (Operation):

26. All exterior lighting shall be shielded and directed downward and away from property lines to prevent excessive glare beyond the subject property.
27. This permit is subject to review, imposition of additional conditions, or revocation if factual complaint is received by the Zoning Officer that the maintenance or operation of this establishment is violating any of these or other required conditions or is detrimental to the health, safety, peace, morals, comfort or general welfare of persons residing or working in the neighborhood or is detrimental or injurious to property and improvements in the neighborhood or to the general welfare of the City.

28. Noise and exterior lighting shall be controlled so as to prevent verified complaints from the surrounding neighborhood.



Pamela Johnson, Assistant Planner for
Eric Angstadt, Director of Planning

ADMIN USE PERMIT FOR GARAGE RENOVATION

PROJECT INFORMATION

OWNER:
BRIAN RODVIEN
415.377.1181

ADDRESS:
1125 CHANNING
BERKELEY CA 94702

APN:
056 192709800

SCOPE OF WORK: REPLACE EXISTING GARAGE. REPLACE WITH OFFICE. FOOTPRINT DOES NOT CHANGE. ADD NEW SLAB, HALF BATH, DOOR & WINDOW, INSULATION, WATERPROOFING, FINISHES TO ROOF AND WALLS. ADD ELECTRICAL, LIGHTING, AND HEATING.

TYPE OF CONSTRUCTION: 1/2 FIRE RESISTIVE (NO CHANGE)

ZONING: R-2

FIRE ZONE: 1

SQUARE FOOTAGE OF GARAGE/OFFICE: 438 SF (NO CHANGE)

STORIES: 1

LIST OF DRAWINGS ATTACHED

- A0.0 PLOT PLAN
- A0.1 PHOTOS, NEIGHBOR SIGNATURES
- A0.2 SITE PHOTO'S
- A1.0 EXISTING PLAN
- A1.1 PROPOSED PLAN
- A1.2 EXISTING ELEVATIONS
- A1.3 PROPOSED ELEVATIONS
- A2.0 INTERIOR ELEVATIONS
- A2.1 BATH ELEVATIONS
- A2.2 DETAIL SECTION

LOCATION PLAN

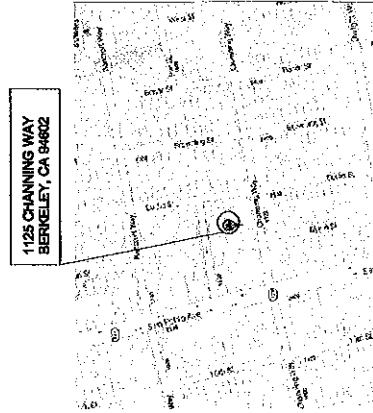

ARCHITECT:
CHRIS SULLIVAN
3018 MARTIN LUTHER KING
BERKELEY CA 94703
415-272-4992
SULLI2@YAHOO.COM

OWNER:
KYRA GORDON &
BRIAN RODVIEN
1125 CHANNING WAY
BERKELEY CA 94702

PROJECT:
ACCESSORY ADDITION/
GARAGE REPLACEMENT
1125 CHANNING WAY
BERKELEY CA 94702

DESCRIPTION

TITLE/PLOT

DATE: DECEMBER, 2013
AUP SUBMITTAL

SHEET:

A0.0

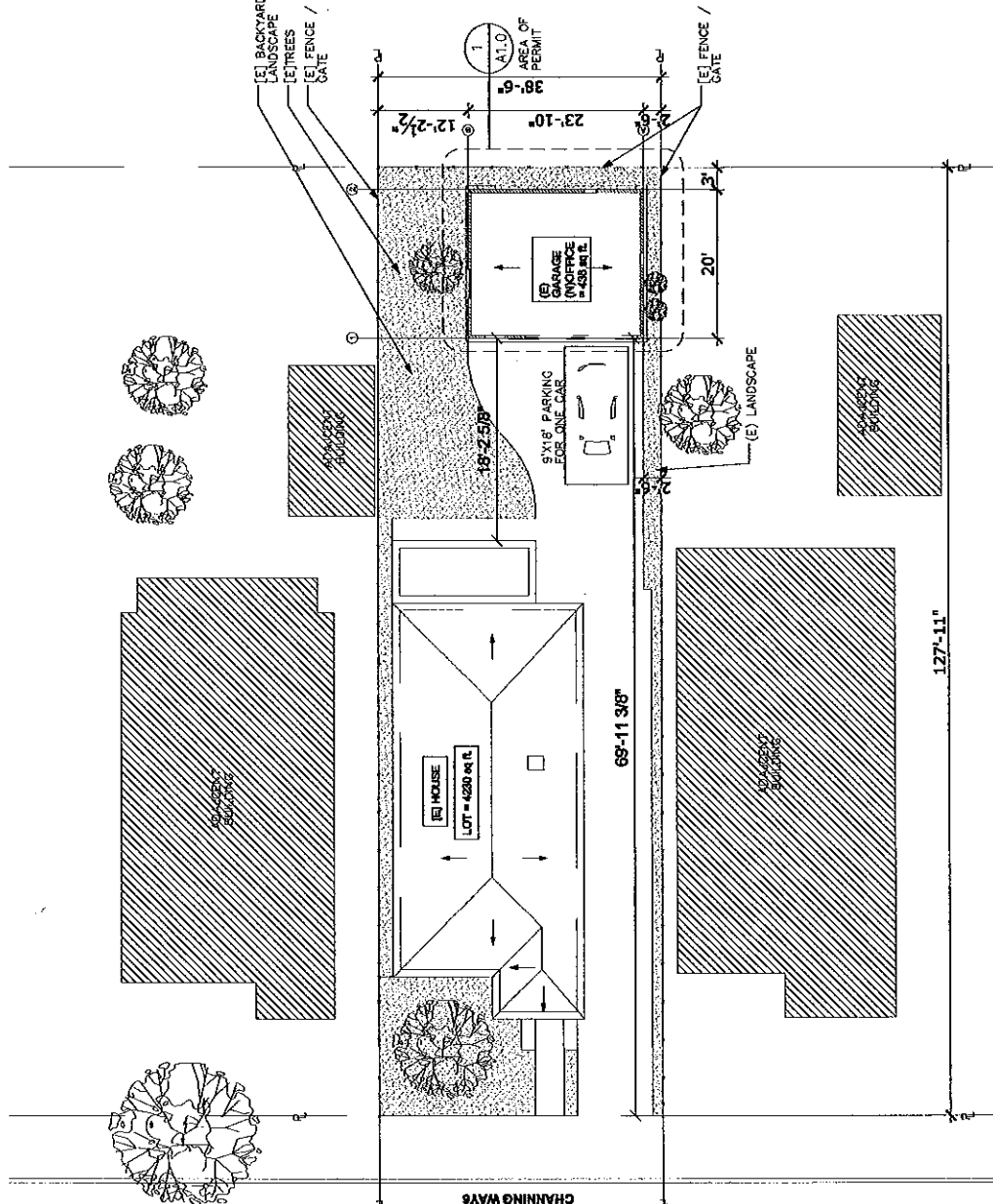

LEGEND

- GARAGE/OFFICE = 438 sq ft.
- (E) LANDSCAPE

APPROVED BY: [Signature]

DEC 17 2013

LAND USE PLANNING

APPROVED PLAN: [Signature] 1.27.13 DATE

PLANNING

- D.R. Conditions Attached
- A.U.P. Conditions Attached
- U.P. Conditions Attached

01 SITE PLAN
1/16"=1'-0"

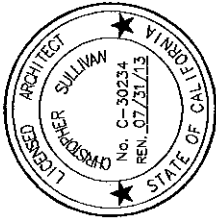

ARCHITECT:
 CHRIS SULLIVAN
 3018 MARTIN LUTHER KING
 BERKELEY CA 94708
 415-272-4992
 SULLI2@YAHOO.COM

OWNER:
 KYRA GORDON &
 BRIAN RODVIEN
 1125 CHANNING WAY
 BERKELEY CA 94702

PROJECT:
 ACCESSORY ADDITION/
 GARAGE REPLACEMENT
 1125 CHANNING WAY
 BERKELEY CA 94702

DESCRIPTION:
 (E) PLAN

DATE:
 DECEMBER, 2013
 AUP SUBMITTAL

SHEET:
A1.0

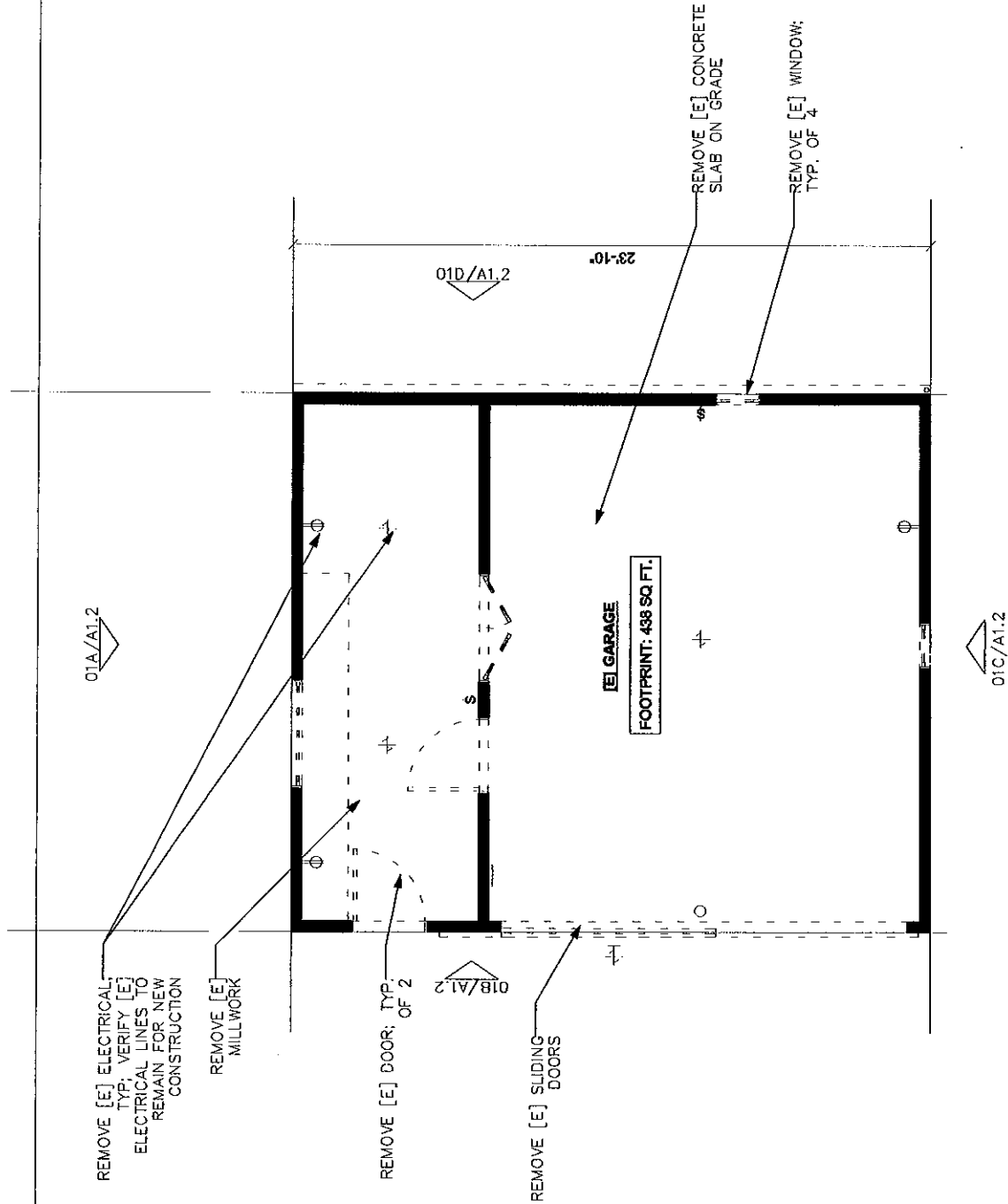

NOTE: ALL [E] CONSTRUCTION TO BE REMOVED; ELECTRICAL LINES TO BE RE-USED FOR NEW CONSTRUCTION

01 EXISTING PLAN - DEMO PLAN
 1/4" = 1'-0"

APPROVED PLAN **1.27.13**
 DATE
 PLANNING
 D.P. Conditions Attached
 A.U.P. Conditions Attached
 U.P. Conditions Attached

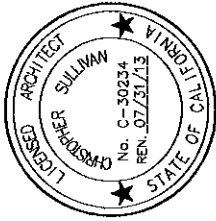

ARCHITECT:
CHRIS SULLIVAN
3018 MARTIN LUTHER KING
BERKELEY CA 94703
415-272-4992
SULLI2@YAHOO.COM

OWNER:
KYRA GORDON &
BRIAN RODVLEN
1125 CHANNING WAY
BERKELEY CA 94702

PROJECT:
ACCESSORY ADDITION/
GARAGE REPLACEMENT
1125 CHANNING WAY
BERKELEY CA 94702

DESCRIPTION:

**EXISTING
ELEVATIONS**

DATE: DECEMBER, 2013
AUP SUBMITTAL

SHEET:

A1.2

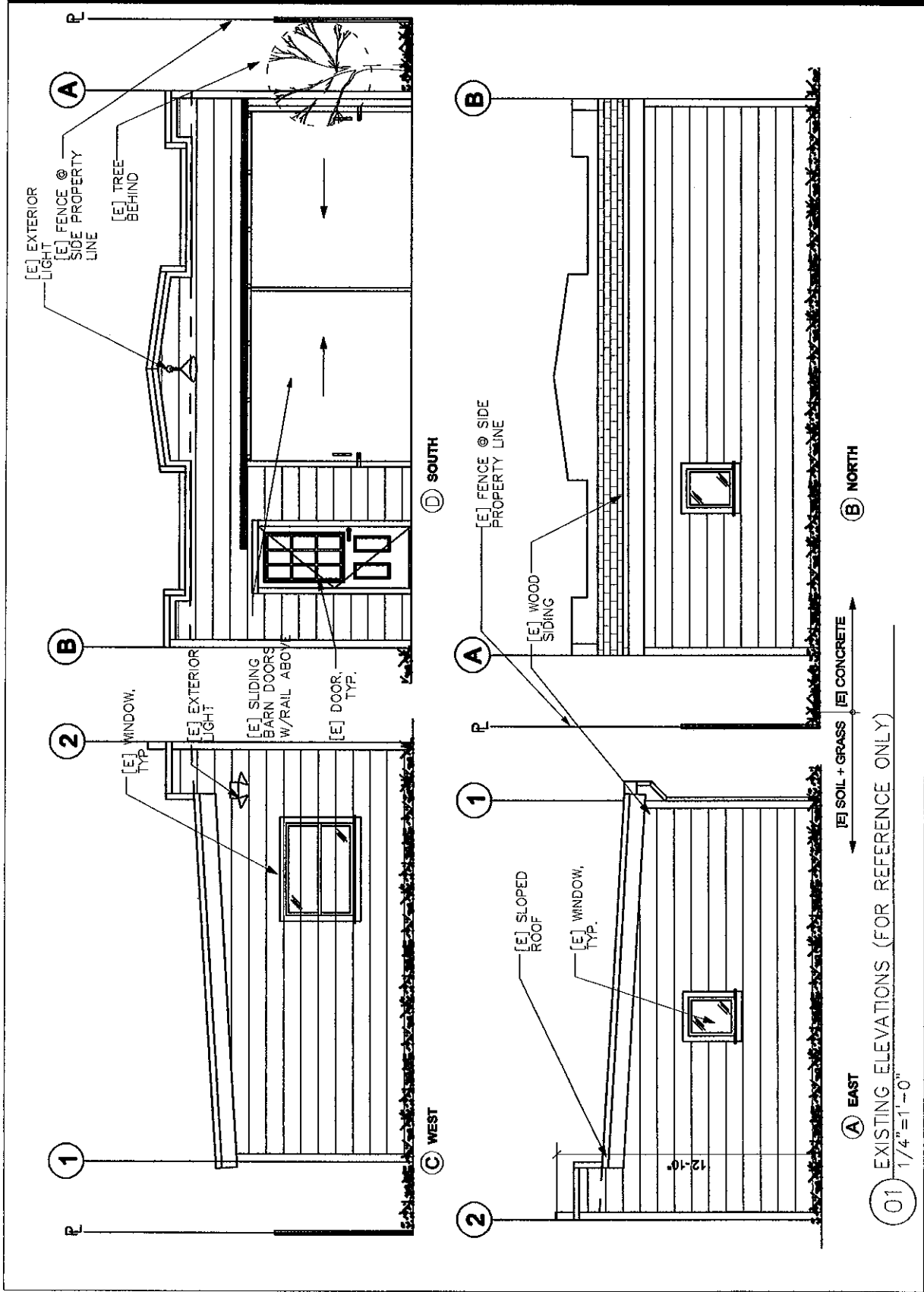

APPROVED PLAN
DRAWING
DATE
1.27.14

D.R. Conditions Attached
 A.U.P. Conditions Attached
 U.P. Conditions Attached

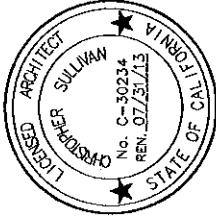

ARCHITECT:
CHRIS SULLIVAN
3018 MARTIN LUTHER KING
BERKELEY CA 94703
415-272-4992
SULLI12@YAHOO.COM

OWNER:
KYRA GORDON &
BRIAN RODVIGEN
1125 CHANNING WAY
BERKELEY CA 94702

PROJECT:
ACCESSORY ADDITION/
GARAGE REPLACEMENT
1125 CHANNING WAY
BERKELEY CA 94702

DESCRIPTION:

PROPOSED ELEVATIONS

DATE: DECEMBER, 2013
A/P SUBMITTAL

SHEET:

A1.3

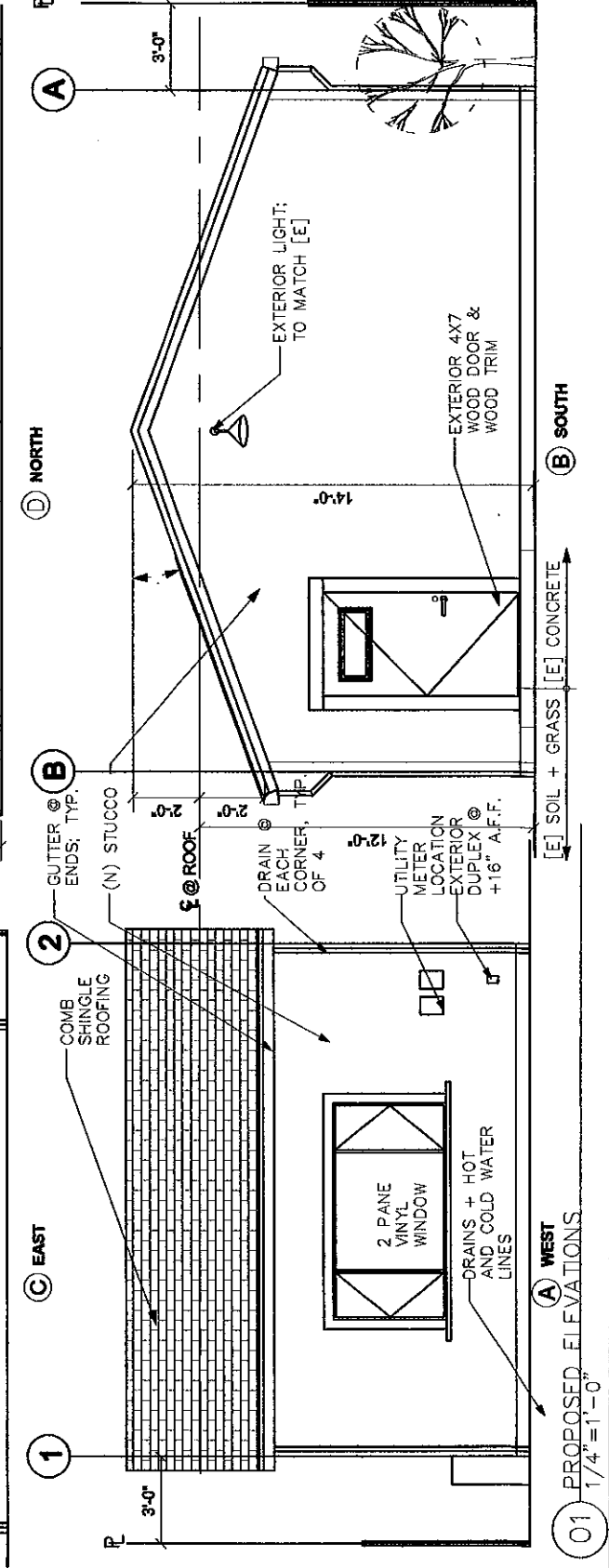
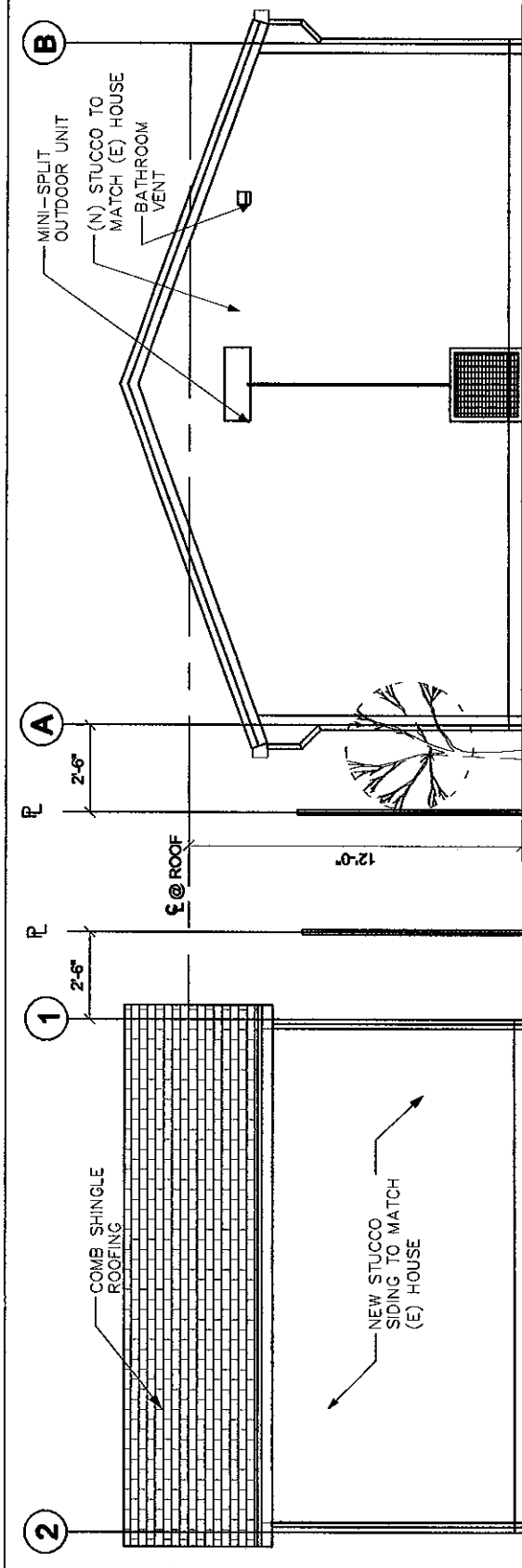

APPROVED PLAN 1.27.14
 Planning DATE
 P.D.R. Conditions Attached
 A.U.P. Conditions Attached
 O.U.P. Conditions Attached

01 PROPOSED ELEVATIONS
1/4" = 1'-0"