



Planning and Development Department
Land Use Planning Division

A D M I N I S T R A T I V E U S E P E R M I T

CITY OF BERKELEY ZONING ORDINANCE
Berkeley Municipal Code, Title 23

AUP #2013-0084

Property Address: **1632 DELAWARE STREET**

Permittee Name: **JEAN-MARC SCHWARZ**

Use and/or Construction Permitted: to legalize an existing 190 square foot accessory building to be used as home office on a 5,694 square foot lot pursuant to:

- Section 23D.08 to create an accessory structure with habitable space.

FINDINGS, CONDITIONS AND APPROVED PLANS ATTACHED

Following the expiration of the mandatory appeal period set forth in Section 23B.28.040 of the Berkeley Municipal Code, with no timely appeal being filed, the Administrative Use Permit described herein has been duly granted by the Zoning Officer on October 16, 2013.

Attest: Terry Blount
Terry Blount, AICP, Principal Planner
For Debbie Sanderson, Zoning Officer

Oct. 16, 2013
Effective Date

ATTACHMENT 1

FINDINGS AND CONDITIONS

SEPTEMBER 25, 2013

1632 Delaware Street

Administrative Use Permit #2013-0084

To legalize an existing 190 square foot accessory building to be used as home office on a 5,694 square foot lot.

CEQA FINDINGS

1. The project is categorically exempt from the provisions of the California Environmental Quality Act (CEQA, Public Resources Code §21000, et seq. and California Code of Regulations, §15000, et seq.) pursuant to Section 15303 of the CEQA Guidelines (“New Construction or Conversions of Small Structures”). Furthermore, none of the exceptions in CEQA Guidelines Section 15300.2 apply, as follows: (a) the site is not located in an environmentally sensitive area, (b) there are no cumulative impacts, (c) there are no significant effects, (d) the project is not located near a scenic highway, (e) the project site is not located on a hazardous waste site pursuant to Government Code Section 65962.5, and (f) the project will not affect any historical resource.

FINDINGS FOR APPROVAL

2. As required by Section 23B.28.050.A of the Zoning Ordinance, the project, under the circumstances of this particular case existing at the time at which the application is granted, will not be detrimental to the health, safety, peace, morals, comfort, and general welfare of the persons residing or working in the neighborhood of such proposed use or be detrimental or injurious to property and improvements of the adjacent properties, the surrounding area or neighborhood, or to the general welfare of the City because:
 - As required under Section 23D.08.A and 23D.08.010.B (Accessory Buildings), the creation of an accessory building that contains habitable space at this location is found to be non-detrimental. The structure is located towards the rear of the property along the western property line in a location with other lawful accessory buildings. The project would not unreasonably obstruct sunlight, air, or views, nor would it cast significant shadows on the windows or a substantial area of open space of adjacent residences because the building will not change.
 - The creation of habitable space within an existing accessory structure is expected to create little or no privacy impacts to the immediate neighbors given that the structure is single story and located in a developed area with mature vegetation that will help filter views. Additionally, the building has been constructed so that all activities are directed towards the interior of the property line, away from adjacent parcels.

STANDARD CONDITIONS

The following conditions, as well as all other applicable provisions of the Zoning Ordinance, apply to this Permit:

1. Conditions Shall be Printed on Plans

The conditions of this Permit shall be printed on the *second* sheet of each plan set submitted for a building permit pursuant to this Use Permit, under the title 'Use Permit Conditions'. *Additional sheets* may also be used if the *second* sheet is not of sufficient size to list all of the conditions. The sheet(s) containing the conditions shall be of the same size as those sheets containing the construction drawings; 8-1/2" by 11" sheets are not acceptable.

2. Applicant Responsible for Compliance with Conditions

The applicant shall ensure compliance with all of the following conditions, including submittal to the project planner of required approval signatures at the times specified. Failure to comply with any condition may result in construction being stopped, issuance of a citation, and/or modification or revocation of the Use Permit.

3. Uses Approved Deemed to Exclude Other Uses (Section 23B.56.010)

- A. This Permit authorizes only those uses and activities actually proposed in the application, and excludes other uses and activities.
- B. Except as expressly specified herein, this Permit terminates all other uses at the location subject to it.

4. Modification of Permits (Section 23B.56.020)

No change in the use or structure for which this Permit is issued is permitted unless the Permit is modified by the Zoning Officer, except that the Zoning Officer may approve changes that do not expand, intensify, or substantially change the use or building.

5. Plans and Representations Become Conditions (Section 23B.56.030)

Except as specified herein, the site plan, floor plans, building elevations and/or any additional information or representations, whether oral or written, indicating the proposed structure or manner of operation submitted with an application or during the approval process are deemed conditions of approval.

6. Subject to All Applicable Laws and Regulations (Section 23B.56.040)

The approved use and/or construction is subject to, and shall comply with, all applicable City Ordinances and laws and regulations of other governmental agencies. Prior to construction, the applicant shall identify and secure all applicable permits from the Building and Safety Division, Public Works Department and other affected City divisions and departments.

7. Exercised Permit for Use Survives Vacancy of Property (Section 23B.56.080)

Once a Permit for a use is exercised and the use is established, that use is legally recognized, even if the property becomes vacant, except as set forth in Standard Condition #8, below.

8. Exercise and Lapse of Permits (Section 23B.56.100)

- A. A permit for the use of a building or a property is exercised when, if required, a valid City business license has been issued, and the permitted use has commenced on the property.
- B. A permit for the construction of a building or structure is deemed exercised when a valid City building permit, if required, is issued, and construction has lawfully commenced.
- C. A permit may be declared lapsed and of no further force and effect if it is not exercised within one year of its issuance, except that permits for construction or alteration of structures or buildings may not be declared lapsed if the permittee has: (1) applied for a building permit; or, (2) made substantial good faith efforts to obtain a building permit and begin construction, even if a building permit has not been issued and/or construction has not begun.

9. Indemnification Agreement

The applicant shall hold the City of Berkeley and its officers harmless in the event of any legal action related to the granting of this Permit, shall cooperate with the City in defense of such action, and shall indemnify the City for any award of damages or attorneys fees that may result.

ADDITIONAL CONDITIONS IMPOSED BY THE ZONING OFFICER

Pursuant to BMC 23B.28.050.D, the Zoning Officer attaches the following additional conditions to this Permit:

Prior to Submittal of Any Building Permit:

10. The applicant shall provide the project planner with the name and telephone number of the individual empowered to manage construction noise from the project. The individual's name, telephone number, and responsibility for noise management shall be posted at the project site for the duration of construction in a location easily visible to the public. The individual shall record all noise complaints received and actions taken in response, and submit written reports of such complaints and actions to the project planner on a weekly basis. **Individual Responsible for Noise Management:**

Name: _____ Phone: _____

11. The applicant and all persons associated with the project are hereby notified that a Transportation Management Permit (TMP) would be required under any of the following circumstances:

- Alterations, closures, or blockages to sidewalks or pedestrian paths
- Alterations, closures, or blockages to vehicle travel lanes (including bicycle lanes)
- Storage of building materials, dumpsters, debris anywhere in the public ROW
- Provision of exclusive contractor parking on-street
- Significant truck activity.

Contact the Permit Service Center (PSC) at 2120 Milvia Street or 981-7500 for details on obtaining Construction/No Parking Permits (and associated signs and accompanying dashboard permits). Public Works Traffic Engineering (981-6400) reviews all submitted TMP requests.

The TMP may include designation of a specific truck haul route. Meter heads (if in the construction area) shall be removed only by City staff. Contact the site inspector 72 hours in advance of required removal so arrangements can be made.

Prior to Issuance of Any Building Permit:

12. Prior to issuance of a building permit, all owners of record of the subject property shall sign and record with the Alameda County Clerk-Recorder a "Notice of Limitation on Use of Property" (available from Land Use Planning Division) and provide a recorded copy thereof to the project planner. This Notice of Limitation shall stipulate that no part of this accessory building shall be used or converted to use as a dwelling unit unless and until permission is requested of the City of Berkeley and authorized by a Use Permit, Administrative Use Permit, or Zoning Certificate, whichever is applicable. This limitation shall include the explicit acknowledgment that no shower, tub, or kitchen facilities may be installed in this habitable accessory building. This limitation may not be revised or removed from this property without the prior written permission of the Zoning Officer of the City of Berkeley.
13. Drainage plans shall be submitted for approval of the Building & Safety Division and Public Works Department, if required.

During Construction:

14. Construction activity shall be limited to between the hours of 8:00 a.m. and 6:00 p.m. on Monday through Friday, and between 9:00 a.m. and noon on Saturday. No construction-related activity shall occur on Sunday or on any Federal Holiday.
15. If underground utilities leading to adjacent properties are uncovered and/or broken, the contractor involved shall immediately notify the Public Works Department and the Building & Safety Division, and carry out any necessary corrective action to their satisfaction.
16. Subject to approval of the Public Works Department, the applicant shall repair any damage to public streets and/or sidewalks by construction vehicles traveling to or from the project site.

17. All piles of debris, soil, sand, or other loose materials shall be covered at night and during rainy weather with plastic at least one-eighth millimeter in thickness and secured to the ground.
18. All active construction areas shall be watered at least twice daily, and all piles of debris, soil, sand or other loose materials shall be watered or covered.
19. Trucks hauling debris, soil, sand, or other loose materials shall be covered or required to maintain at least two feet of board.
20. Public streets shall be swept (preferably with water sweepers) of all visible soil material carried from the site.
21. The applicant shall establish and maintain drainage patterns that do not adversely affect adjacent properties and rights-of-way.
22. The applicant shall ensure that all excavation takes into account surface and subsurface waters and underground streams so as not to adversely affect adjacent properties and rights-of-way.
23. Any construction during the wet season shall require submittal of a soils report with appropriate measures to minimize erosion and landslides, and the developer shall be responsible for following these and any other measures required by the Building and Safety Division and the Public Works Department.

Prior to Issuance of Occupancy Permit or Final Inspection:

24. All construction at the subject property shall substantially conform to the approved Use Permit drawings or to modifications approved by the Zoning Officer.
25. All landscape, site and architectural improvements shall be completed per the attached approved drawings dated **JULY 3, 2013**.

At All Times (Operation):

26. All exterior lighting shall be shielded and directed downward and away from property lines to prevent excessive glare beyond the subject property.
27. This permit is subject to review, imposition of additional conditions, or revocation if factual complaint is received by the Zoning Officer that the maintenance or operation of this establishment is violating any of these or other required conditions or is detrimental to the health, safety, peace, morals, comfort or general welfare of persons residing or working in the neighborhood or is detrimental or injurious to property and improvements in the neighborhood or to the general welfare of the City.

28. Noise and exterior lighting shall be controlled so as to prevent verified complaints from the surrounding neighborhood. .



Claudine Asbagh, Assistant Planner for
Debbie Sanderson, Zoning Officer

SCHWARZ RESIDENCE

1632 DELAWARE STREET, BERKELEY

Detached Workshop to Office Conversion

PROJECT DIRECTORY

VICINITY MAP

DATE TO SCALE

PROJECT DATA

OWNER: SCHWARZ RESIDENCE
 ARCHITECT: SCHWARZ ARCHITECTS
 PROJECT NO: 1632-01
 DATE: 07/02/2013
 SHEET NO: 1 OF 1
 SCALE: AS SHOWN
 PROJECT DATA

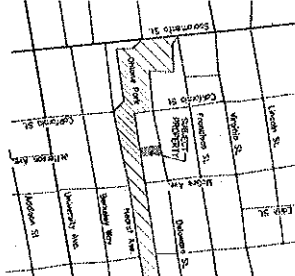

SYMBOLS

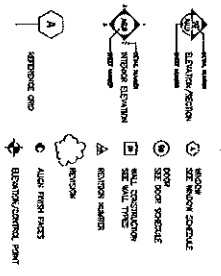

SHEET INDEX

Sheet	Description	Author	Date	Revision
1	Site Plan	AS	07/02/2013	1
2	Floor Plans	AS	07/02/2013	1
3	Section	AS	07/02/2013	1
4	Detail	AS	07/02/2013	1

PLEASE REFER TO THE PLAN SET FOR AN OVERVIEW OF THE ENTIRE DETACHED WORKSHOP TO AN OFFICE CONVERSION AT 1632 DELAWARE STREET.

ASSESSOR MAP

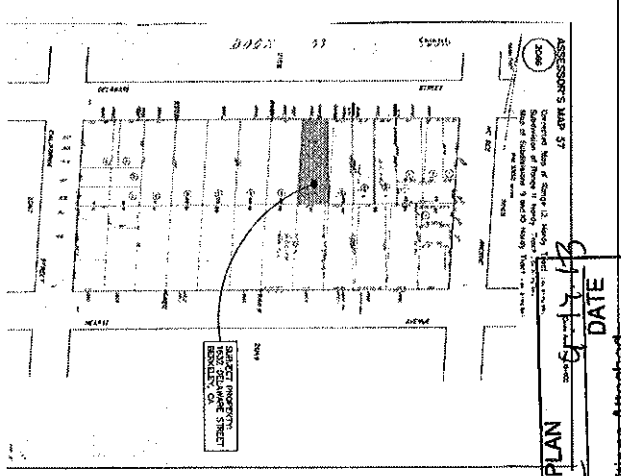

DATE: 07/02/2013
 PLAN NO: 1632-01
 U.P. Conditions Attached
 S.A.U.P. Conditions Attached
 U.P. Conditions Attached

SANBORN MAP

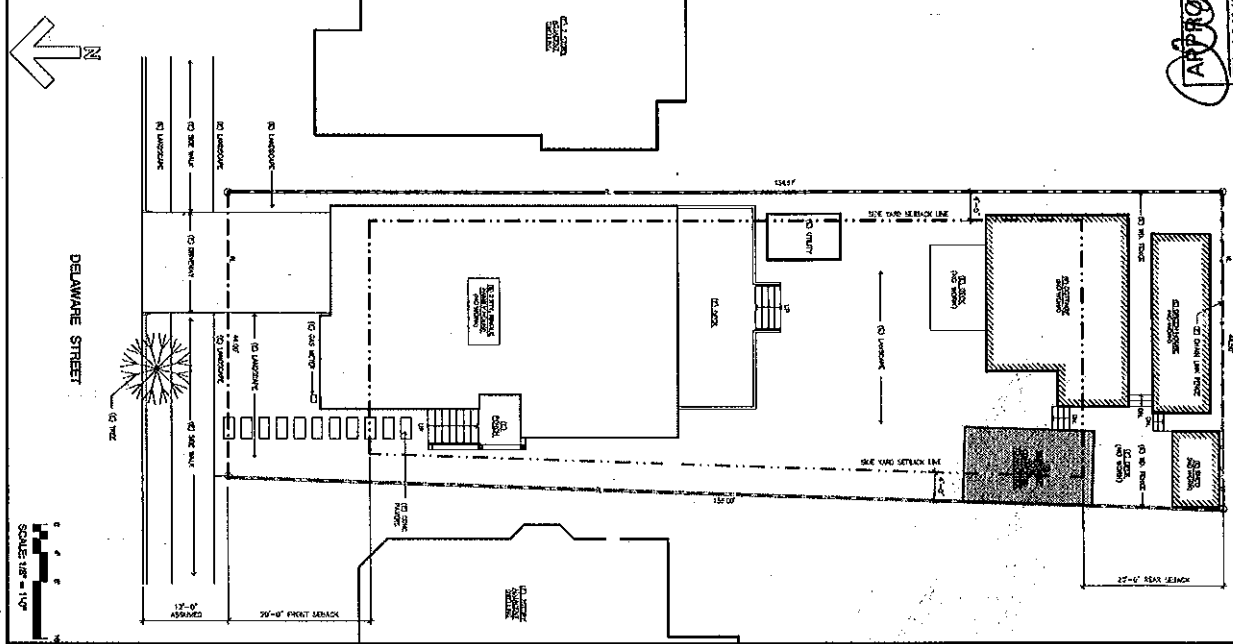
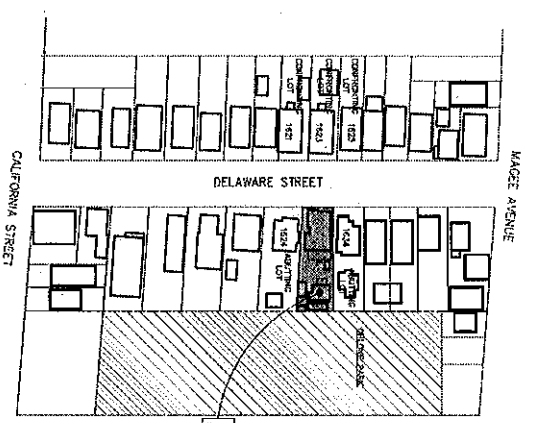

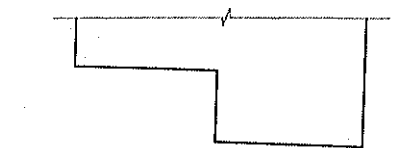

3 ROOF PLAN
SCALE: 1/8" = 1'-0"

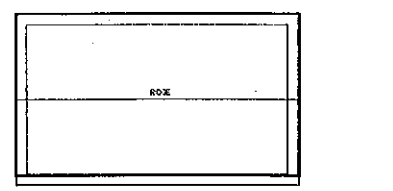

2 FLOOR PLAN
SCALE: 1/8" = 1'-0"

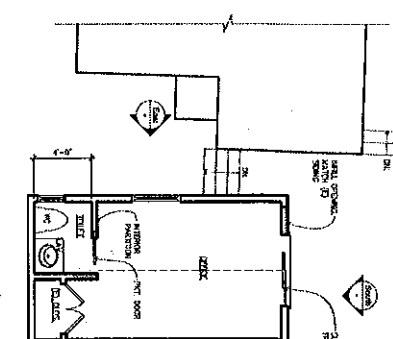

1 DEMOLITION PLAN
SCALE: 1/8" = 1'-0"

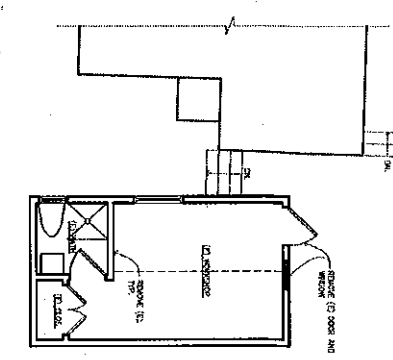

LEGEND

- EXISTING STRUCTURE
- NEW STRUCTURE

SHEET NOTES

- ALL DEMOLITION WORK TO BE DONE BY THE CONTRACTOR.
- ALL NEW WORK SHALL BE DONE IN ACCORDANCE WITH THE 2013 CALIFORNIA BUILDING CODE.

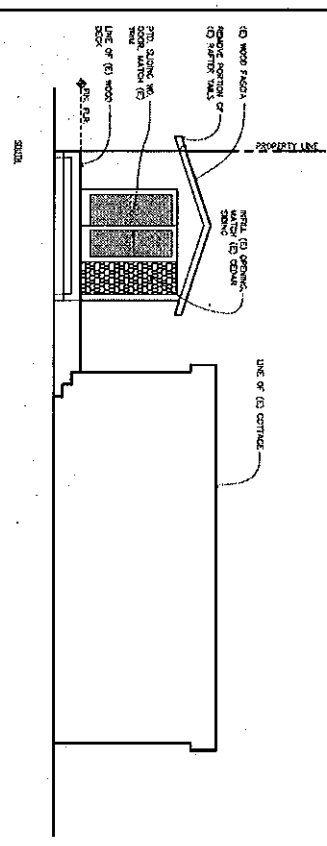

4 EXTERIOR ELEVATIONS
SCALE: 1/8" = 1'-0"

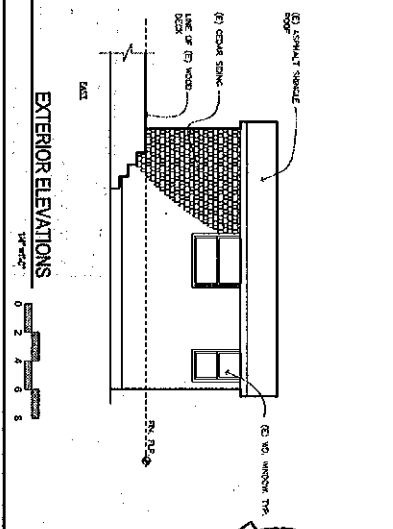
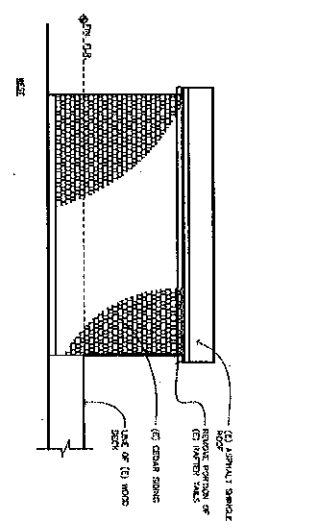
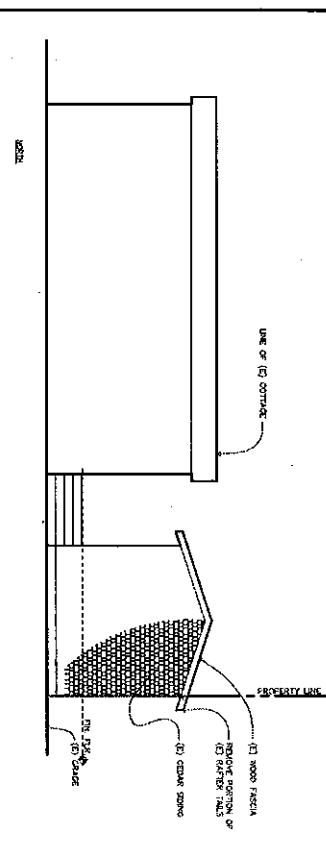

APPROVED PLAN
 PLANNING
 E.D.R. Conditions Attached
 E.B.A.U.P. Conditions Attached
 E.U.P. Conditions Attached
 DATE 9/17/13

SCHWARZ RESIDENCE
 DETACHED WORKSHOP TO OFFICE CONVERSION
 1832 DELAWARE STREET
 BERKELEY, CALIFORNIA



LEVIN HILL
 ARCHITECTS
 4373 SHARPE AVENUE
 BERKELEY, CA 94705
 TEL: 415.841.2500
 FAX: 415.841.2501

DATE 07-02-2013
 APPROVED BY
 Floor Plans
 Elevations
 and Exterior
 A1